

Variapro

- ✓ Versatile
- ✓ Fast: Adjustable speed from 120 to 240 slices / minute
- ✓ Easy: Intuitive touch interface
- ✓ Design: Full stainless steel or painted steel finish
- ✓ Maximum safety
- ✓ Exemplary hygiene

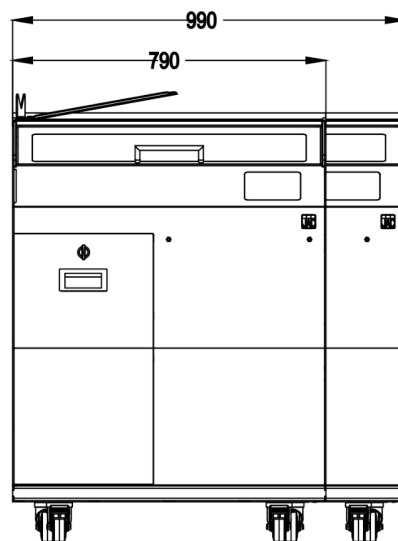
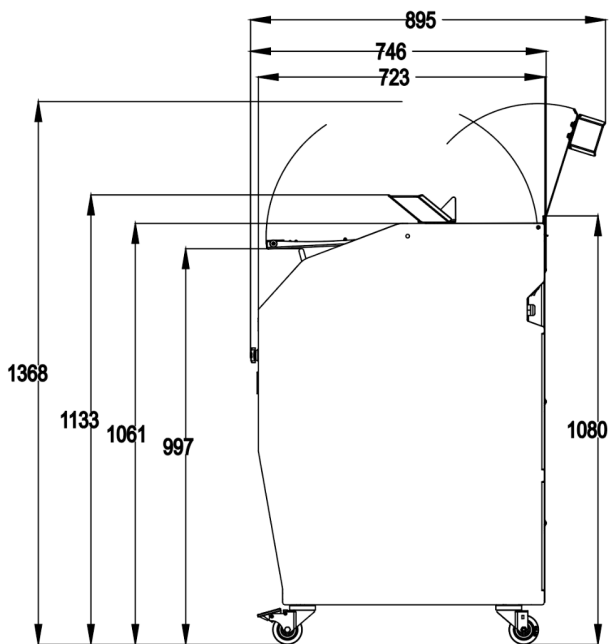

SPECIFICATIONS

Size of entry channel (L x W x H) in cm	46 x 34 x 16
Slice thickness in mm	Can be set from 5 to 25mm
Power supply	230V single-phase
Motor power in kW	0.75
Net weight (in kg)	230
Cleaning position	•
Manual claw	•
Blade type	Teflon-coated
GS certification	•



Options (Additional cost)	Clips box, Bag holder, Front bagger stand, Sourdough bread holder, Slice thickness display
---------------------------	--

MAIN STRENGTHS

	<p>Smooth and quiet for all breads</p> <p>New engine generation designed for maximum precision on a wide range of breads, without lubrication. Soft start and stop function.</p>		<p>Teflon coated circular blade</p> <p>Developed to cut through a large variety of breads; from soft to dense, with a hard crust, and even sticky breads.</p>
	<p>Adjustable speed up to 240 slices/ minute</p> <p>In order to reach the fastest possible speed for each bread type.</p>		<p>Planetary blade drive</p> <p>Fluid blade movement, avoids back-and-forth shakes. Robust solution for long-term mechanical reliability.</p>
	<p>Touch screen interface</p> <p>Clear and simple interface, for an immediate and intuitive use.</p>		<p>Automatic grip (option)</p> <p>Just place the bread and the machine does the rest while you continue to serve your customers.</p>
	<p>Manual grip</p> <p>For all kinds of breads, including sharp ends. Allows to minimize last slice width.</p>		<p>Multi-positions adjustable bagging spade</p> <p>Rotating spade, above cutting chamber, to optimize ergonomics and hygiene. Two standard (left and right) bagging spade positions. Or non-rotating front position (option).</p>



Upper cover

Prevents objects placed on the machine (e.g. bags) to be pushed inadvertently behind the machine when opening the front cover. Rotates for easy cleaning.



Easy to access power switch

Accessible from the front of the machine, but not visible; avoids operations by a non-authorized person.



Maximum safety

Highest safety standards, for machine use by consumers and staff. The blade cannot run when the machine is not 100% locked.



Anti-pinch design

Users cannot inadvertently pinch their fingers in the front cover sliders.

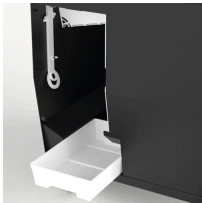

Easy & fast cleaning

Internal architecture designed to channel bread crumbs to an easily accessible crumb tray. Flat surfaces (without recess around).



Bread slicer GS certified by TÜV

The GS certification (Geprüfte Sicherheit - "Safety Tested" in English) guarantees the safety of products and the protection of users' health. This highest level of certification ensures an absolute degree of safety for users.